



David
Manufacturing Co.

*Grain
Flow*

MAKING PRODUCTS AS RELIABLE AS THE PEOPLE WHO USE THEM.

Efficient
Reliable
Accurate

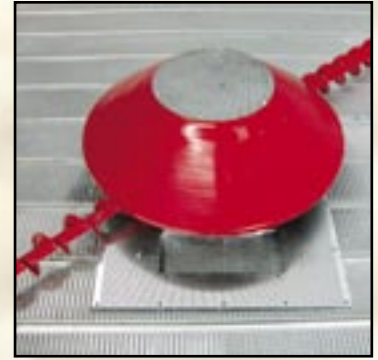
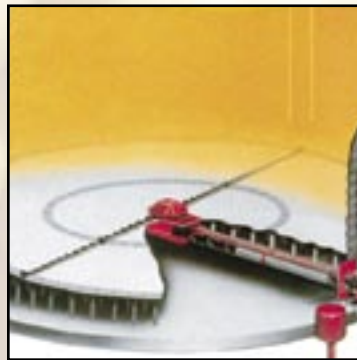

Automatic In-Bin Continuous Flow Grain Drying

Grain Flow

DMC's Best:

Grain Flow with Optional Calc-U-Dri and Stir-Ator

The best grain management system from DMC features Calc-U-Dri, Stir-Ator, and Grain Flow. These components convert your drying bin into the ultimate automatic in-bin continuous flow drying system.

Turn Your Best Bin into the Most Efficient Continuous Flow Drying System Available.

The optional Calc-U-Dri is a revolutionary master control for automatic, in-bin continuous flow grain drying. Calc-U-Dri keeps grain moisture content no higher than 0.3% over set point (percentage moisture desired). It also controls the Grain Flow and take-away systems.

The Calc-U-Dri sensor, located in the Grain Flow discharge tube, monitors all the grain leaving the drying bin. Wall mounted monitors can never match Calc-U-Dri sensor accuracy.

Model 84 Grain Flow features an eight inch discharge auger with 700 bushel per hour discharge capacity using dual floor augers.

With the addition of a Stir-Ator, your bin becomes a wet holding tank with a capacity of up to 16 feet deep, a continuous flow dryer of unmatched efficiency, and a dry and store unit for the last bin full.

The optional Trans-Fer 700 pneumatic grain conveying system gives your system the added flexibility needed for multi-bin operations.

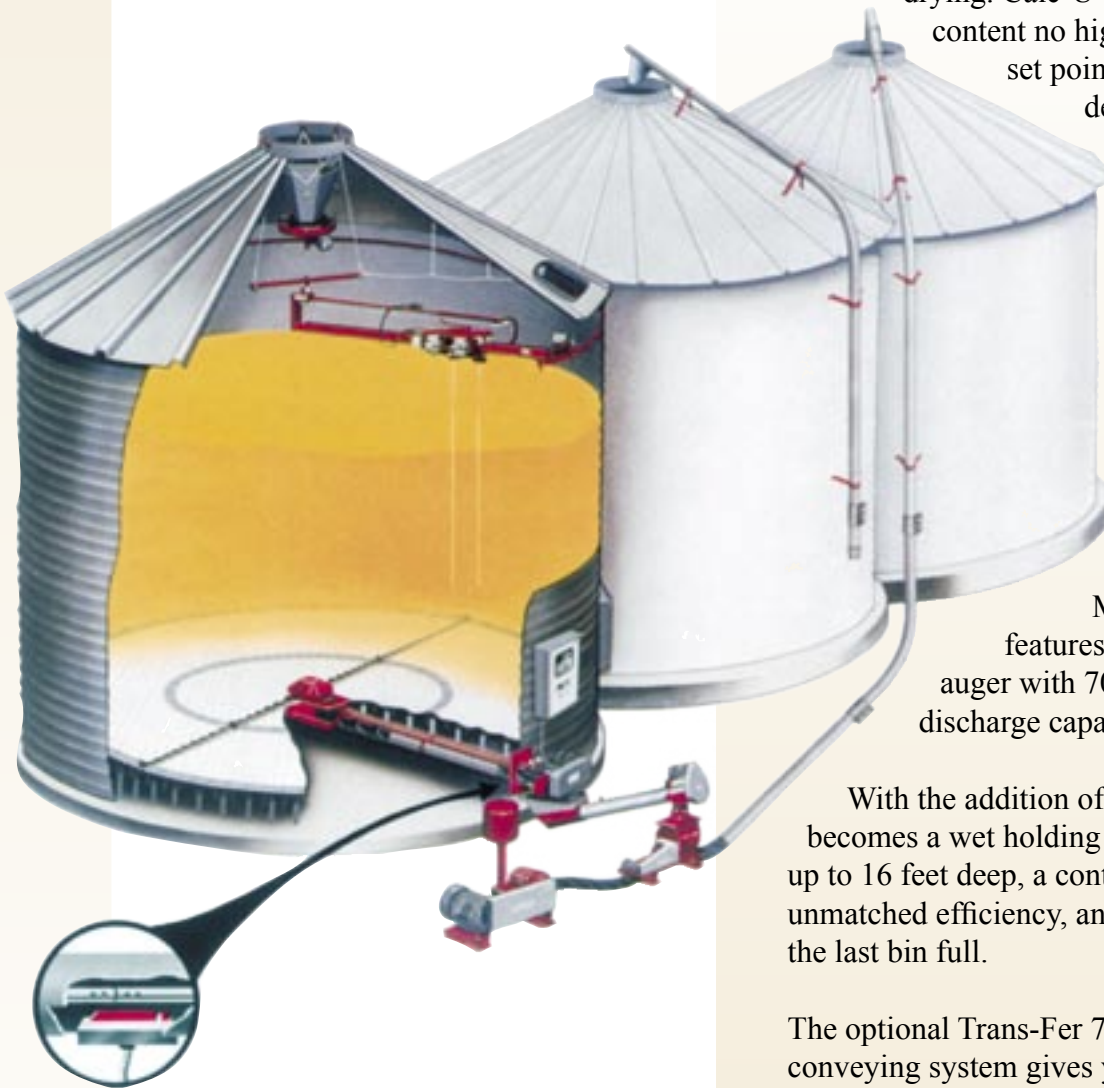

Model 84

Grain Flow



DMC's Grain Flow with Calc-U-Dri and Stir-Ator has a list price that averages much less than competitive systems of similar capacity.

Grain Flow with Calc-U-Dri can also be used without the Stir-Ator. However, grain drying depth is limited to four (4) to eight (8) feet for maximum efficiency and capacity. (Stiffeners must be used without stirring.)

Features and Benefits:

- Exterior control box means your total drying system is operated from one convenient location.
- Support feet move floor augers through grain at a smooth even pace.
- Hood and floor auger design allows grain to be evenly removed at up to 700 bushels per hour (limited only by fan and heater drying capacity).
- Auger overload switch shuts down the entire system, should transfer equipment fail.
- Heavy duty construction of all components ensures long life.

Optional Equipment for the Grain Flow:

- Take-away auger control box
- Incline transfer augers
- Discharge auger extensions
- Trans-Fer pneumatic conveying systems
- 8" x 18' or 20' vertical auger with accessories
- Bin-full switch to stop Grain Flow when storage bin is full
- Single or three phase, 220V or 440V electrical options
- Vertical auger heads (two or three way) with chain operated valve
- Grain Level Monitor
- Hard surfaced floor augers (rice only)

Calc-U-Dri's

Direct Moisture Sensing is Revolutionary



Solid state electronics eliminate the need for special equipment or buildings to house the unit. The Calc-U-Dri is designed to be operated in the farm environment.

Unique Sensor Designed for Durability and Reliability



If you have an older Grain Flow system, there is a Calc-U-Dri Retrofit for you. Retrofits are available for Shivers, Neco, and Sukup in-bin systems. For out-of-bin dryers, ask your DMC dealer about a Moisture/Matic dryer controller.

Why hasn't someone made this before?

DMC recognized the need for more efficient dryer controls. A solution was visualized and DMC went after it. Twenty years of refinement has resulted in a drying system control unparalleled anywhere. Unique electronic circuitry make Calc-U-Dri the most accurate and reliable direct moisture sensing control available for in-bin continuous flow grain drying at an affordable price.

Calc-U-Dri Puts Your Mind at Ease

How many times have you thought it would be nice to set the desired grain moisture on your dryer, then walk away and not worry about it because you know your grain will be properly dried? Calc-U-Dri provides this assurance. Here's how it works:

- 1. Turn the power on**
- 2. Turn all switches to automatic**
- 3. Push start button**
- 4. Dial desired moisture**

Immediately on start up the Calc-U-Dri automatically allows the grain to dry from 15 to 60 minutes (the operator chooses the initial drying period depending upon the amount of moisture to be removed from the grain). This is followed by a two minute discharge period when grain moisture is sampled as the grain is emptied from the bin.

Calc-U-Dri's stainless steel sensor is simple and uses capacitance-type sensing to accurately calculate grain moisture. As grain passes over the Calc-U-Dri sensor located in the discharge tube, every bushel of grain is checked for moisture content. If moisture is 0.3% higher than set point (the selected moisture content set by the operator), the Calc-U-Dri goes back into another drying period. If lower, the Calc-U-Dri allows the Grain Flow to continue to discharge grain until moisture levels increase to 0.3% above set point when the Calc-U-Dri stops the discharge of grain and goes back into a drying period for additional drying.

Calc-U-Dri Components

Operations Flow Chart

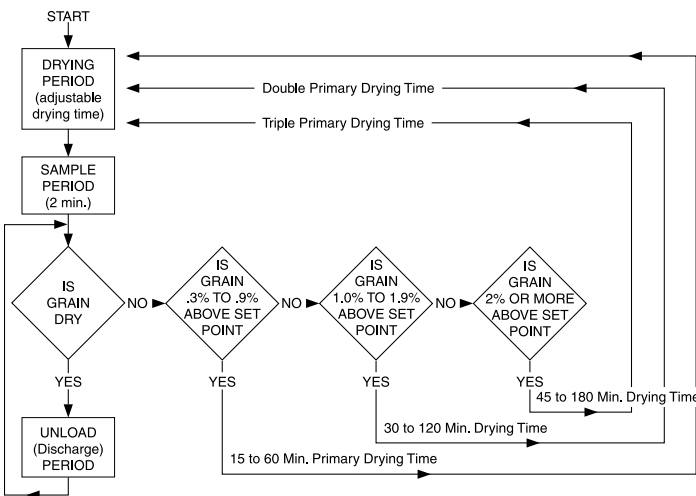

In the drying period, grain is dried to the desired moisture. This time is manually adjustable. In the sample period, the unit will auger out grain for two minutes. At the end of the two minute sample, the Calc-U-Dri continues to discharge grain. Or if the grain is not dry, it selects a drying time based on the grain moisture of the sample. If the grain is dryer than the moisture limit set point, the Calc-U-Dri will auger out grain until wet grain is sensed. At this time, it goes back to the drying period.

Special Features:

• On-delay Timer

Three (3) seconds before the Grain Flow starts, the Calc-U-Dri starts the take-away system, minimizing peak power loads.

• Sensor Location

Location of the Calc-U-Dri sensor in the discharge auger makes it the only moisture monitor that accurately checks the moisture content of every bushel of grain being discharged. Wall mounted sensors can monitor only in their immediate area.

• Adjustable Off-delay Timer (1-100 Sec.)

The take-away system continues to run 20 seconds after the Grain Flow stops discharging grain, emptying the take-away system of grain.

• Universal Usage

Use with all grains in all environmental conditions. Adjustable drying periods on the Calc-U-Dri allow for accurate use with all grain in all types of weather.

Drying Cycle Features

Moisture level of discharged grain	Calc-U-Dri goes to...
Lower than 0.3% above set level	Discharge Cycle
0.3% to 0.9% above set level	15 to 60 minute drying cycle
1.0% to 1.9% above set level	30 to 120 minute drying cycle
2.0% or higher above set level	45 to 180 minute drying cycle

- **Push to Read Temperature:** Push button and grain temperature reads out on the digital display.
- **Push to Set Moisture Limit:** Push this button and turn the Moisture Limit Adjustment knob to select set point (the desired grain moisture content). Moisture set point will read out in the display.
- **Moisture Offset:** Dial the percentage of moisture that is to be adjusted to the moisture readout. This amount will be added to or subtracted from the moisture readout.
- **Auto/Manual Switch:** Allows the Calc-U-Dri to be operated in automatic or manual modes.
- **Control Power Switch:** On/Off power switch for the Calc-U-Dri.
- **Start/Stop Button:** Starts or stops the Calc-U-Dri.
- **Sample Indicator Lamp:** Lights up when the two minute sample is being taken.
- **Drying Time Adjustment:** Set the initial drying time from 15 to 60 min. The Calc-U-Dri will automatically double or triple drying time (of whatever position set) depending on grain moisture content.
- **Take-Away Auger Power Switches:** Allows take-away equipment to be run manually, automatically, or turned off.
- **Electric Sensor:** Mounted in the discharge auger tube, the sensor dielectronically

measures grain moisture content in every bushel of discharged grain. Temperature is compensated for automatically, to give an accurate moisture reading. Most other sensors only measure grain or air temperature.

Model 84

Grain Flow Components



Control Box

The DMC Grain Flow with Calc-U-Dri is operated from a control box located on the outside of the bin. Operating lights and three contactor switches are located in the box. These switches control auxiliary equipment, such as take away augers, and can be operated automatically or manually for easy maintenance checks.

Power System

The power system is located on the discharge end of the Grain Flow to provide power directly to the gear box, thus simplifying installation by virtually eliminating alignment adjustments. This also provides for a left or right discharge option for added flexibility. The motor's three belt drive ensures no slip operations. A shift lever is conveniently located to engage or disengage floor augers. The optional vertical auger is powered by it's own electric motor.

Calc-U-Dri Printer

Use DMC's Calc-U-Dri Printer to gather as much information as possible about your grain drying system.

The printer records all the important data necessary to make those critical evaluations of your grain drying system. Plus, you have all the information needed to calculate the moisture percentage your grain will stabilize at, once it has completely cooled.

The printer will display the following information:

- Date
- Moisture Limit
- Bin Number
- Relative Humidity
- Moisture Offset
- Plenum Temperature
- Time of Moisture Samples
- Machine Status - i.e. wet, dry, sample
- Grain Moisture
- Ambient Temperature
- Average Grain Moisture



Optional Trans-Fer Air System

**CALC-U-DRI
PRINTER SAMPLE**

Model 84

Grain Flow Components

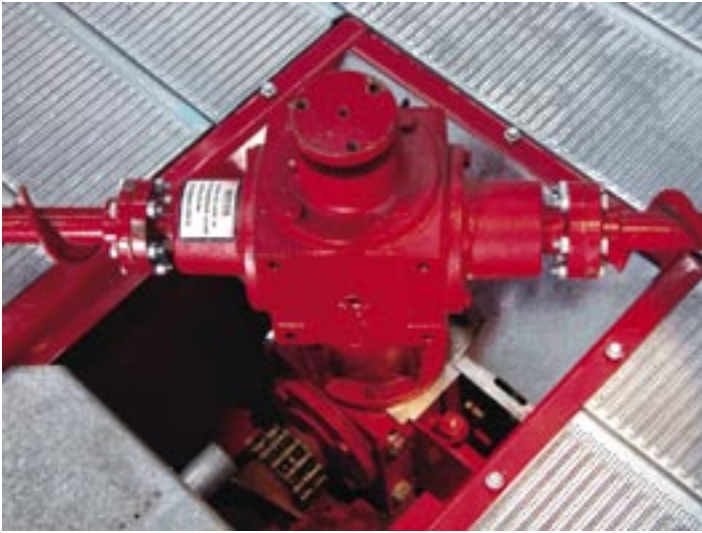

Rugged Gear Box

The gear box features timken tapered roller bearings, high temperature grease seals and case hardened gears. Adjustable legs allow the gear box to fit plenums form 12 to 20 inches.

Unique Improved Hood Design

Grain Flow's unique hood keeps grain from free-flowing from the bin's center. There is no need for a resistor ring or grain paddles that damage grain.

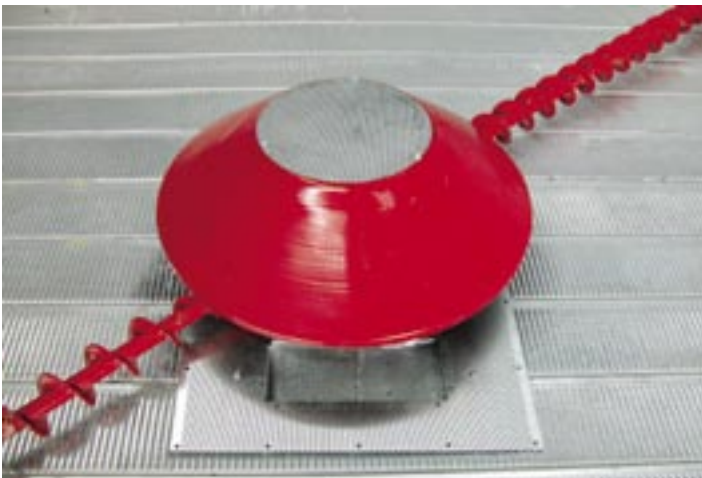

Dual Floor Augers

Grain Flow's gear box uses tough 1-1/4" case hardened shafts to drive dual floor augers with hefty shafts and heavy-duty flighting. These augers unload grain at up to 700 bushel per hour (BPH) or 1500-2000 BPH using the slide gate.

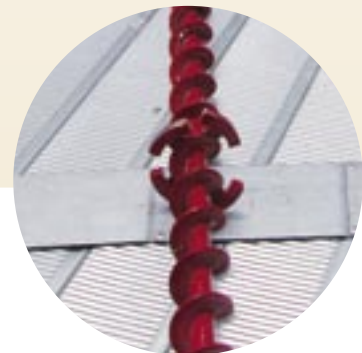
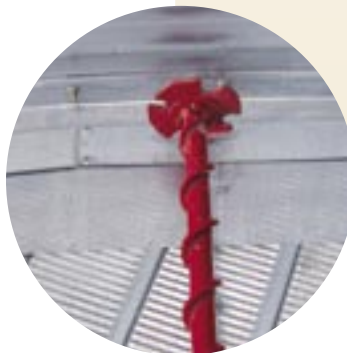

Augers Turn on Inner and Outer Wear Plates.

```

-----D.M.C. CALC-U-DRI-----
01-07-05  SETPOINT 16.4  BIN # 1
R.H. 0 % CALIBRATION -0.3  PLENUM 60
HIT ANY KEY FOR MENU          CORN
  TIME  CALC  GRAIN  GRAIN  AMB  AVE
  MODE  MODE  MOIST  TEMP  TEMP MOIST
-----
11:22P  WET  16.5   116   0   16.5
11:39P  SAMP  16.3   116   0   16.5
11:44P  DRY  16.3   116   0   16.5
11:49P  DRY  16.3   116   0   16.5
11:53P  WET  16.5   116   0   16.5
  
```

Grain Flow Drying Capacities

Bin Size	Fan HP	Drying Rate Multipliers For More Fans		CFM	Static Pressure	Drying Capacity (BU/24 Hrs.) Heat Rise Above Ambient Temperature					
		2 Fans	3 Fans			25	50	75	100	125	150
18'	5	1.2	na	8700	2.7	590	1200	1840	2490	3160	3860
	7.5	1.2	na	9800	3.2	670	1360	2070	2800	3560	4350
21'	5	1.4	na	10000	2.1	680	1380	2110	2860	3640	4440
	7.5	1.4	na	10800	2.3	740	1500	2280	3090	3930	4790
	10	1.3	na	12000	2.7	820	1660	2530	3430	4360	5330
	12.5	1.4	na	12900	3.0	880	1790	2720	3690	4690	5730
24'	7.5	1.6	na	11400	1.7	780	1580	2410	3260	4150	5060
	10	1.5	na	13000	2.0	890	1800	2740	3720	4730	5770
	12.5	1.5	na	14000	2.3	950	1940	2950	4010	5090	6220
	10C	1.7	na	12500	1.9	850	1730	2640	3580	4550	5550
	15C	1.6	na	14900	2.5	1010	2060	3140	4260	5420	6610
	20C	1.6	na	17700	3.3	1210	2450	3740	5060	6440	7860
27'	7.5	1.7	na	11900	1.2	810	1650	2510	3400	4330	5280
	10	1.6	na	13300	1.5	910	1840	2810	3810	4840	5900
	12.5	1.6	na	14800	1.7	1010	2050	3120	4230	5380	6570
	10C	1.8	na	12900	1.4	880	1790	2720	3690	4690	5730
	15C	1.7	na	15600	1.9	1060	2160	3290	4460	5670	6930
	20C	1.7	na	18500	2.4	1260	2560	3900	5290	6730	8210
30'	30C	1.6	na	21400	3.1	1460	2960	4520	6120	7780	9500
	7.5	1.8	na	12200	1.0	830	1690	2570	3490	4440	5420
	10	1.8	na	13700	1.1	930	1900	2890	3920	4980	6080
	12.5	1.7	na	15300	1.3	1040	2120	3230	4380	5560	6790
	10C	1.8	na	13200	1.1	900	1830	2790	3780	4800	5860
	15C	1.7	na	16100	1.4	1100	2230	3400	4610	5860	7150
33'	20C	1.7	na	19100	1.9	1300	2640	4030	5460	6950	8480
	30C	1.7	na	22100	2.3	1510	3060	4660	6320	8040	9810
	10	1.8	na	13800	0.9	940	1910	2910	3950	5020	6130
	12.5	1.8	na	15600	1.0	1060	2160	3290	4460	5670	6930
	10C	1.8	na	13400	0.8	910	1860	2830	3830	4870	5950
	15C	1.8	na	16400	1.1	1120	2270	3460	4690	5960	7280
36'	20C	1.8	na	19500	1.4	1330	2700	4120	5580	7090	8660
	30C	1.8	na	22600	1.8	1540	3130	4770	6470	8220	10030
	10	1.9	na	13900	0.7	950	1920	2930	3980	5060	6170
	12.5	1.8	na	15900	0.8	1080	2200	3360	4550	5780	7060
	10C	1.9	na	13600	0.7	930	1880	2870	3890	4950	6040
	15C	1.8	na	16600	0.9	1130	2300	3500	4750	6040	7370
42'	20C	1.8	na	19800	1.1	1350	2740	4180	5660	7200	8790
	30C	1.8	na	23000	1.4	1570	3180	4850	6580	8360	10210
	10	2.0	2.8	14000	0.4	950	1940	2950	4010	5090	6220
	12.5	1.9	2.6	16200	0.6	1100	2240	3420	4630	5890	7190
	15C	1.9	2.7	16900	0.6	1150	2340	3570	4840	6150	7500
	20C	1.9	2.6	20100	0.8	1370	2780	4240	5750	7310	8920
48'	30C	1.9	2.6	23500	0.9	1600	3250	4960	6720	8550	10430
	40C	2.2	2.7	27000	1.1	1840	3740	5700	7720	9820	11990
	10	2.0	2.9	14100	0.3	960	1950	2980	4030	5130	6260
	12.5	1.9	2.7	16400	0.5	1120	2270	3460	4690	5960	7280
	15C	1.9	2.8	17100	0.4	1160	2370	3610	4890	6220	7590
	20C	1.9	2.8	20300	0.5	1380	2810	4280	5810	7380	9010
48'	30C	1.9	2.7	23700	0.6	1610	3280	5000	6780	8620	10520
	40C	2.0	2.8	27100	0.8	1850	3750	5720	7750	9860	12030
	50C	1.9	2.7	32500	1.0	2210	4500	6860	9300	11820	14430

The chart below gives approximate corn drying capacities of DMC Grain Flow with various combinations of bin diameter, heat rise and fan and heater sizes. The chart is based on 50° F ambient temperature and 60% relative humidity with starting grain temperature of 50° F. Moisture removal is from 24% to 16-1/2%. Cooling will remove an additional 1% to 2% moisture content. When grain is dried in depths over 8 ft., a Grain Stir-Ator installed in conjunction with a Grain Flow will increase drying efficiency.

Capacities given are for shelled corn. Information on drying other grains is available from your DMC distributor. All multiple fans are in parallel. Multiply Drying Rate x .77 for 10 pt. removal. Multiply Drying Rate x 1.35 for 5 pt. removal. All multiple fan static pressures (where multipliers are shown) fall within acceptable performance guidelines.



For more information on DMC's complete line of equipment visit us online at: www.dmc-davidmanufacturing.com.

Distribution Centers

Illiana Distribution Center

1004 E. Illinois St,
Assumption, IL 62510
Ph: 217-226-5100
Fax: 217-226-5070

Clear Lake Distribution Center

5205 4th Ave. S.
Clear Lake, IA 50428
Ph: 641-357-3386
Fax: 641-357-1928

